

SITRANS F US

Ultrasonic flowmeter type SITRANS FUS380

Ultrasonic flowmeter type SITRANS FUE380

(type-approved for heat metering)



Technical Documentation (handbooks, instructions, manuals etc.) for the complete product range SITRANS F can be found on the internet/intranet via the following link:

English: <http://www4.ad.siemens.de/WW/view/en/10806951/133300>

Order no.: A5E00730100

SFIDK.PS.022.Q5.02



Introduction	1
General safety instructions	2
Description	3
Installation	4
Electrical connection	5
Operation	6
Troubleshooting	7
Sealing	8
Technical data	9
Ordering	10
Appendix	11

Table of contents

1	Introduction	4
1.1	Preface	4
2.	General safety instructions	4
2.1	Safety notes	4
2.2	Manufacturer's design and safety statement	4
3.	Description	6
3.1	Product description	6
3.2	Service	6
4.	Installation	7
4.1	Installation of sensor compact/remote versions	7
4.2	Installation of transmitter compact/remote versions	9
4.2.1	General information	9
4.2.2	Insulation	9
4.2.3	Mains powered version	9
4.2.4	Wiring diagram for mains power supply, pulse output	9
4.2.5	Mains powered units with back-up battery	10
4.3	Battery powered version	11
4.4	Installation of the transmitter, remote version	12
4.4.1	Installation of wall/pipe bracket	12
4.4.2	Connection of transducer cables	12
4.4.3	Transducer connection scheme	13
4.4.4	Wiring diagram, base of connection board	13
5.	Electrical connection	14
5.1	Pulse output A and B setting	14
5.1.1	FUE380 preset pulse output A settings dedicated to energy calculator type SITRANS FUE950	14
5.1.2	FUS380 and FUE380 preset output B settings	15
5.1.3	Wiring diagram for connection to energy calculator type SITRANS FUE950	16
6.	Operation	17
6.1	Flowmeter operation via key and display	17
6.2	Operator menu	18
6.3	Information symbols	19
7.	Troubleshooting	19
7.1	Alarm code	19
8.	Sealing	20
8.1	User sealing of the SITRANS FUE380	20
8.2	Verification sealing of the SITRANS FUE380	20
9.	Technical data	21
9.1	Technical data SITRANS FUS380 and FUE380	21
9.2	Dimensional drawings for FUS380 and FUE380	22
9.2.1	Pipe dimensions for FUS380 and FUE380	22
10.	Ordering	24
10.1	FUS380 selection and ordering data	24
10.2	FUE380 (type approved) selection and ordering data	26
10.3	Spare parts for FUS380 and FUE380	28
11.	Appendix	29
11.1	EC Declaration of Conformity	29

Introduction

1

1.1 Preface

These instructions contain all the information required to commission and use the SITRANS FUS ultrasonic flowmeter types FUS380 and the type-approved flowmeter FUE380 for heat metering systems.

These instructions are intended to assist personnel performing mechanical installation, electrical connection and commissioning of the device, as well as service and maintenance engineers.

General safety instructions

2

2.1 Safety notes



For safety reasons it is important that the following points, especially those marked with a warning sign, are read and understood before the system is installed:

- Installation, connection, commissioning and service must be carried out by personnel who are qualified and authorized to do so.
 - It is very important for any person working with the equipment to read and understand the instructions and directions provided in this manual and follow instructions and directions before using the equipment.
 - Only personnel authorized and trained by the owner of the equipment may operate the equipment.
 - Installation personnel must ensure that the measuring system is correctly connected in accordance with the connection diagram.
 - For applications involving high working pressures or media that can be dangerous to people, surroundings, equipment or other in the event of pipe fracture, Siemens recommends taking precautions such as special placement, shielding or installation of a safety guard or safety valve prior to installation of the sensor.
 - Repair and service may be performed by approved Siemens Flow Instruments personnel only.
-

2.2 Manufacturer's design and safety statement



- Responsibility for the choice of flowmeter pipe material as regards abrasion and corrosion resistance lies with the purchaser. The effect of any change in process medium during operation of the meter should be taken into account. Incorrect selection of flowmeter pipe material could lead to failure of the flowmeter.
 - Stresses and loading caused by earthquakes, traffic, high winds and fire damage are **not** taken into account during flowmeter design.
-

-
- Do **not** install the flowmeter such that it acts as a focus for pipeline stresses. External loading is **not** taken into account during flowmeter design.
 - Please aware about the risk of installing the sensor in a highly vibrating environment. Parts may shake loose and the complete system must be monitored in that case.
 - Flanges and joints as well as related pressure/temperature (p/t) classification has been described in EN 1092-1. See ferrite steel group 1E1: table 15.
 - During operation do **not** exceed the pressure and/or temperature ratings indicated on the data label or in this Operating Manual.
 - It is recommended that all installations include an appropriate safety valve and adequate means for draining.
 - Under the „Pressure Equipment Directive“ (PED), this product is a pressure accessory and not approved for use as a safety accessory, as defined by the PED.



- **DANGER**
Do not unscrew the transducers during pipe operation (especially for DN 50 ... DN 80).

Battery operation:

- When battery operated, SITRANS FUS380 and FUE380 is not covered by the „Low Voltage Directive“ (LVD). Hence, an installation can be considered in conformance with LVD, only when the SITRANS FUS380 /FUE380 is connected to equipment conforming to LVD.
- Lithium batteries are primary power sources with high energy content. They are designed to meet the highest possible safety standard. They may, however, present a potential hazard if they are abused electrically or mechanically. This is in most circumstances associated with the generation of excessive heat, where increased internal pressure may cause the cell to rupture.

Thus the following basic precautions should be observed when handling and using lithium batteries:

- Do not short-circuit, recharge, overcharge or connect with false polarity.
 - Do not expose to temperature beyond the specified temperature range or incinerate the battery.
 - Do not crush, puncture or open cells or disassemble battery packs.
 - Do not weld or solder to the body of the battery.
 - Do not expose contents to water.
- Lithium batteries are regulated under United Nations Model Regulations on Transport of Dangerous goods, UN document ST/SGAC.10-1, 12th revised edition, 2001. UN no. 3091 class 9 covers lithium batteries packed with or inside the equipment. UN no. 3090 class 9 covers transportation of batteries on their own.
Thus the following basic precautions should be followed when transporting lithium batteries:
 - Transport only in special packaging with special labels and transportation documents.
 - Exercise caution in handling, transportation and packaging in order to prevent short circuiting of the batteries.
 - The gross mass of the package is limited according to the type of transportation. In general, a gross mass below 5 kg is acceptable for all forms of transportation.
 - Remove the battery from transmitter before returning the flowmeter to Siemens for service or warranty claim.

3.1 Product description

The 2-track ultrasonic flowmeter SITRANS FUS380 and approved SITRANS FUE380 comes as battery or mains powered and is designed to measure water flow in district heating plants, local stations, substations, chiller plants and other general water applications including treated waste water.

The SITRANS FUS flowmeter is available in the following variants:

- FUS380: A universal flowmeter with selectable settings.
- FUE380: A type-approved flowmeter dedicated to measure flow in a heating system. SITRANS FUE380 is approved according to heat meter standards EN 1434 class 2, OIML R75 class 2 and MID. FUE380 may be marked „neutral“ or have a country-specific approval label, depending on selection of flowmeter setup when ordering.

Both flowmeter types SITRANS FUS380 and FUE380 are available in either compact or remote versions and electrical wiring and operation are identical for both types. The maximum permissible distance between sensor and transmitter is 30 meters.

The flowmeter comes as a transmitter part FUS080 and a sensor part FUS300. This two parts can be only ordered together as a flowmeter system type FUS380 or FUE380. For FUS380 a spare part transmitter can be ordered separate (see FI01 catalogue). For FUE380 is this not allowed according the approvals. For both systems the sensor part cannot be ordered without a transmitter.

In FUS380 parameters and pulse output are preset from factory and protected via software lock. A software tool is required to change parameters.

In FUE380 - metrological parameters and pulse output are preset from factory and protected via hardware lock and sealings to avoid manipulation.

No settings of installation are required as all parameters are set from factory (plug and play).

Maximum temperature compact for DN 50 ... 1200 sensors 2 ... 120 °C (35,6 ... 248 °F).

Maximum temperature remote version DN 100 ... 1200 steel sensors 2 ... 200 °C (35,6 ... 392 °F) and for DN 50 ... 80 red brass sensors 2 ... 150 °C (35,6 ... 302 °F).

Accessories for correct pipeline assembly and use of flanges gaskets are not Siemens Flow Instruments A/S responsibility.

3.2 Service

In order to locate and diagnose failures, a software tool for diagnosis and re-programming of outputs is available. Failure information is available on the display. Failures are stored in memory, and can be accessed via the infra-red communication port.

(Software for diagnosis and setting of parameters is available from Siemens Automation and Drives, Process Instrumentation and Analytics).

4.1 Installation of sensor compact/remote versions

Requirement for straight inlet before flowmeter

In order to maximise performance it is necessary to have straight inlet and outlet flow conditions before and after the flowmeter.

Furthermore, a minimum distance between flowmeter and pumps and valves must be respected.

It is also important to centre the flowmeter in relation to flanges and gaskets.

Make sure that the flowmeter is positioned as low as possible to prevent air from being trapped in the flowmeter at the transducers.

Find a position on the pipeline where the inlet pipe to the flowmeter has a straight length as specified below.

Note

For MID approved FUE380 systems the following inlet pipe is recommend:

L2 for sizes > DN 80: 1.5 m (2 m) or

L2 for sizes < DN 65: 10 x DN.

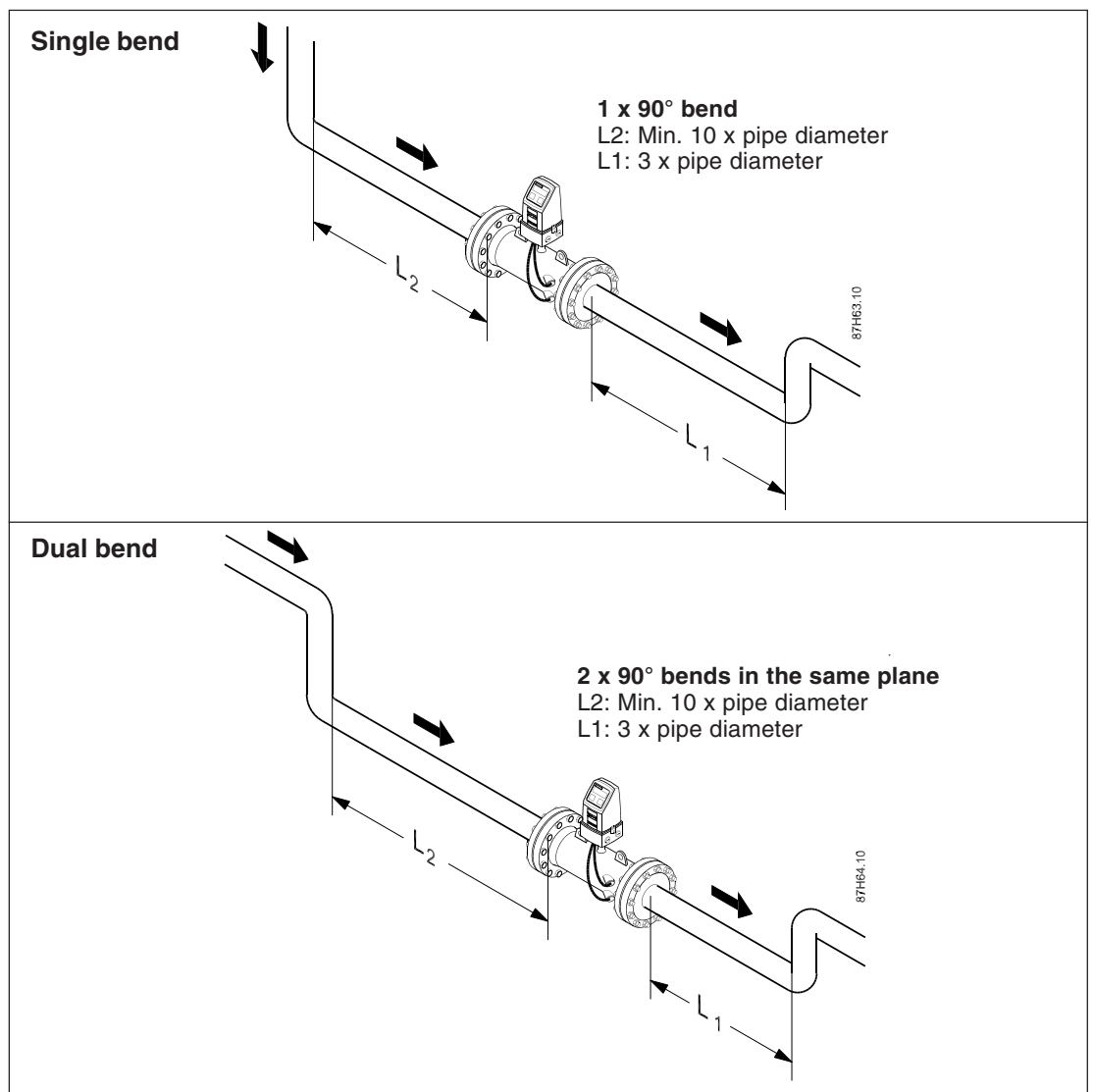

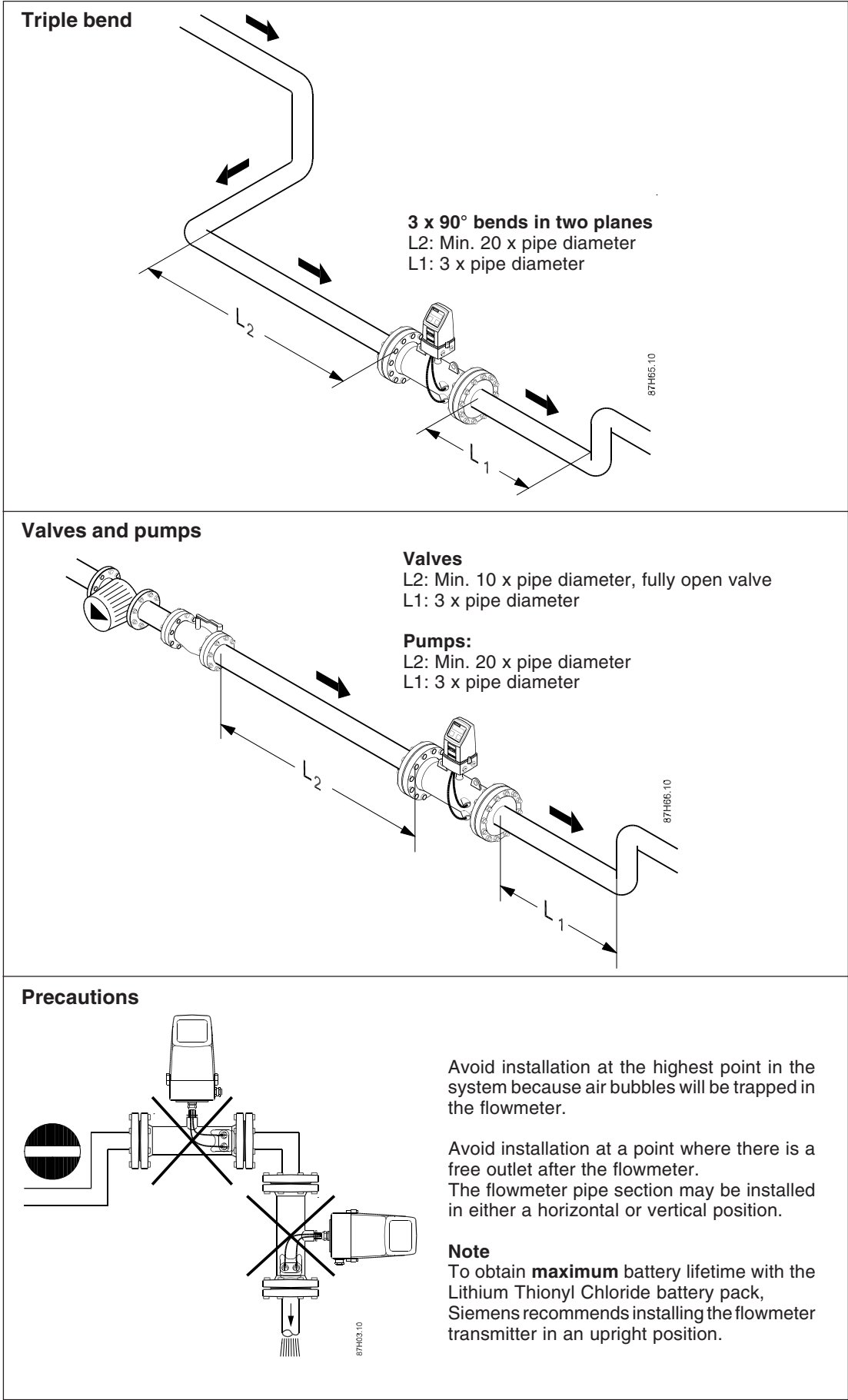

4.2 Installation of transmitter compact/remote versions

4.2.1 General information

The transmitter is packed separately - ready for plug-in into the base part.

SITRANS FUS380 and FUE380 may be mains powered or battery powered. Determine the flowmeter power source type by reading the label or via the product code.

Important:

A transmitter ordered as only battery powered **cannot** be updated with additional mains power, because no mains power supply circuits are installed in this transmitter type.

On compact versions, all transducer cables are pre-mounted from factory.

Mounting of output pulse cables is identical for compact and remote versions.

4.2.2 Insulation

Both versions can be insulated.

Siemens always recommends insulation of the sensor in the **compact version** to prevent heat transfer to the transmitter. The recommendation applies to both battery powered and mains powered versions.

4.2.3 Mains powered version

The mains powered version can always be retrofitted with a battery pack.

In the event of power failure the battery will take over the power supply of the unit.

The battery is **not** of a rechargeable type. The battery must be replaced every 6 years.

At delivery the transmitter may be pre-mounted with a battery pack. Alternatively, the battery pack must be installed before use. (See section „Battery powered version“).

Note

The male battery plug is **not** connected to the plug female socket connection upon delivery. This connection must be made to enable the back-up battery power supply. Please refer to the section „Battery powered installation“ for further details.

4.2.4 Wiring diagram for mains power supply, pulse output



Always disconnect mains supply before removing the transmitter top part (mains powered units only).



Important

Cable binder **must** be fastened to printed circuit board according to drawing.

Top of connection board

Mains powered units: Terminal L1, N, terminal 
 Voltage: 87 V AC...250 V AC

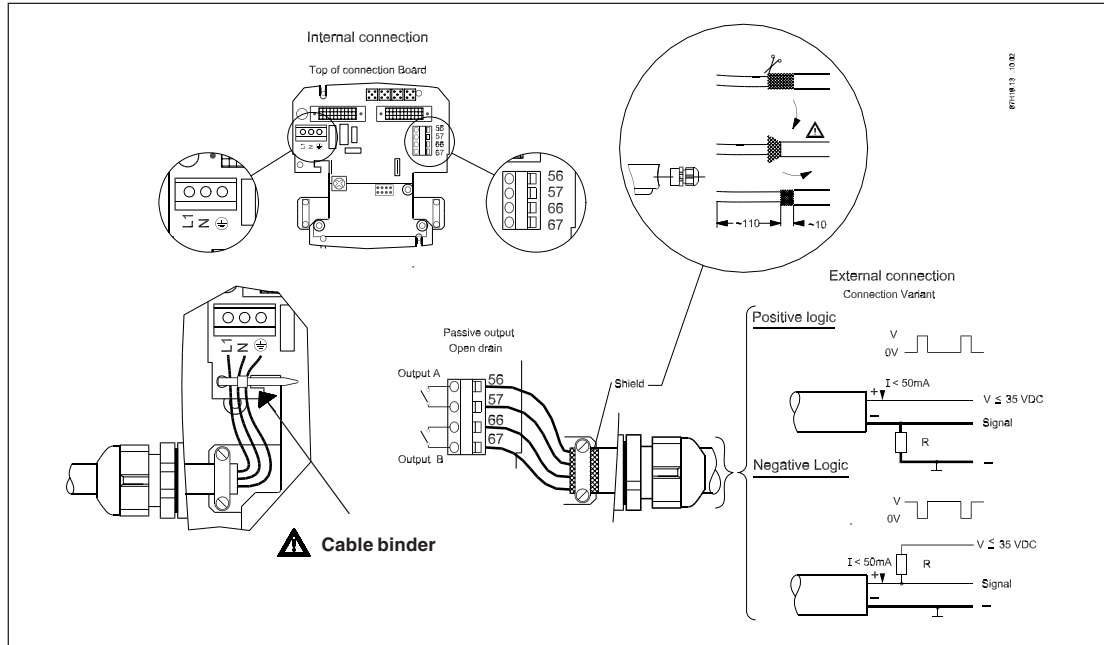

Potential hazards grounding

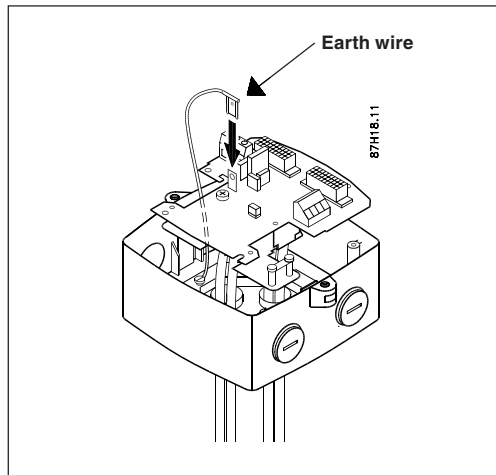

In mains powered units the protective earth wire must be connected to the PE  on the printed circuit board using the connector.

Do **not** touch the rear of the printed circuit board.

4.2.5 Mains powered units with back-up battery

If SITRANS FUS380 and FUE380 is mains powered, a battery can be inserted as back-up power supply to ensure continuous operation in the event of power failure. Depending on duration and numbers of mains power failures, the battery has a lifetime of minimum 6 years (one battery). (Average: one mains power failure per day (duration 1 hour) for min. 6 years).

Check that the mains power supply symbol appears in the display when installation is complete. This symbol indicates that installation is correct. If the mains power supply connection is not established correctly, the flowmeter will operate on battery power only. Battery life will be significantly shorter if batteries are used continuously as opposed to only occasionally in a back-up function.

4.3 Battery powered version

SITRANS FUS380 and FUE380 is prepared for up to 2 batteries of 3.6 V.

When two batteries are installed in the battery pack it will have an operation life of minimum 6 years under normal temperature conditions (please refer to FI01 catalog).

Unscrew the battery cover to insert the battery pack.

Connect the small plug-in between the two main connectors. Ensure that the wire is inserted into the small channel leading from plug to battery.

Note

Siemens recommends replacing the battery every 5 - 6 years.

Every time a battery is fitted and connected, the unit runs a start up routine, see section: „Operation“.

Changing the battery does not influence the accumulated value. Accumulated values can **only** be reset using PC software.

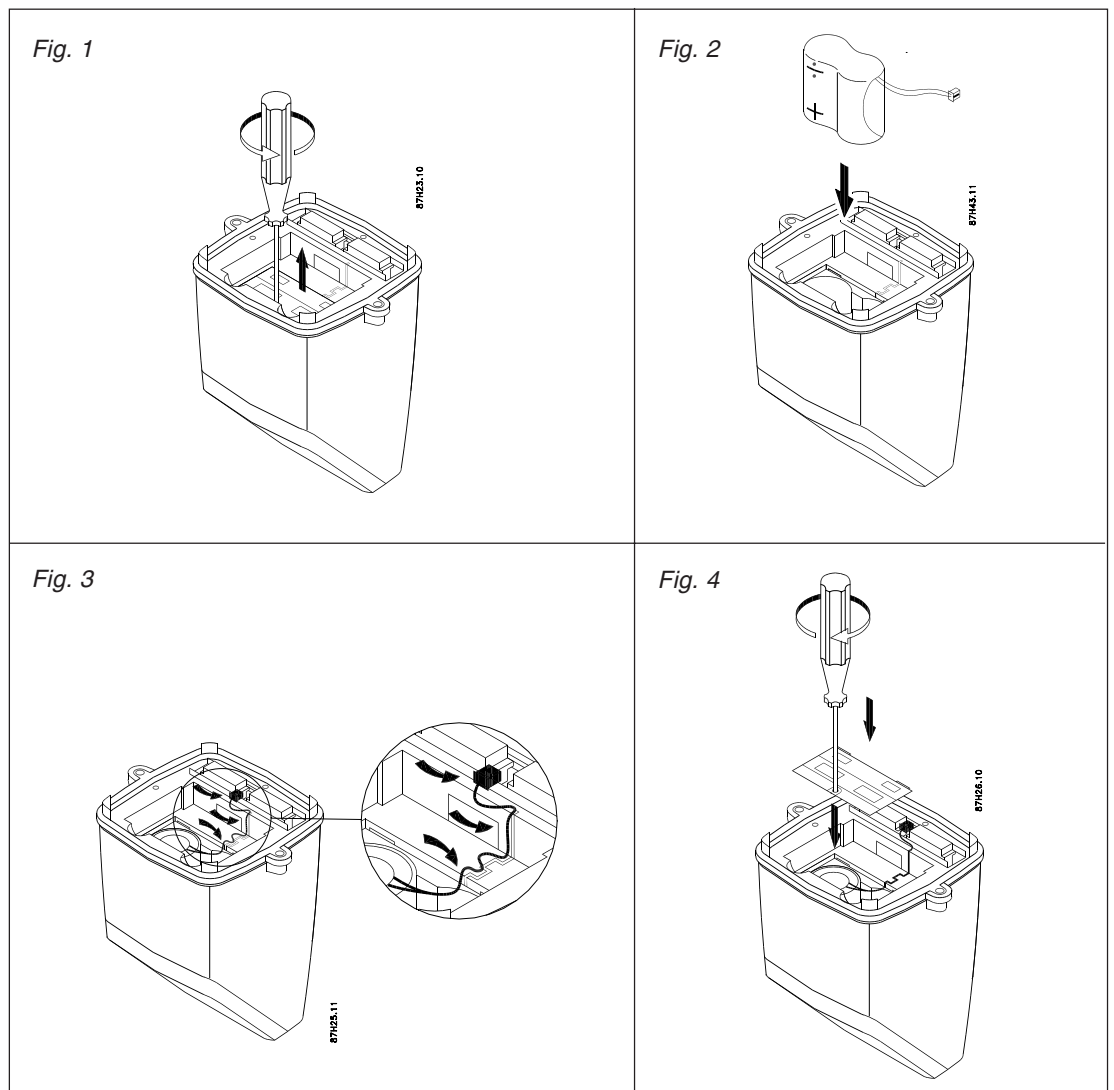

4.4 Installation of the transmitter, remote version

4.4.1 Installation of wall/pipe bracket

1. Loosen the 2 screws on each side of the unit and remove the transmitter.
2. Mount the wall bracket in an appropriate place taking the coaxial cable length into consideration, and allowing adequate space for cable inlets underneath and on both sides.

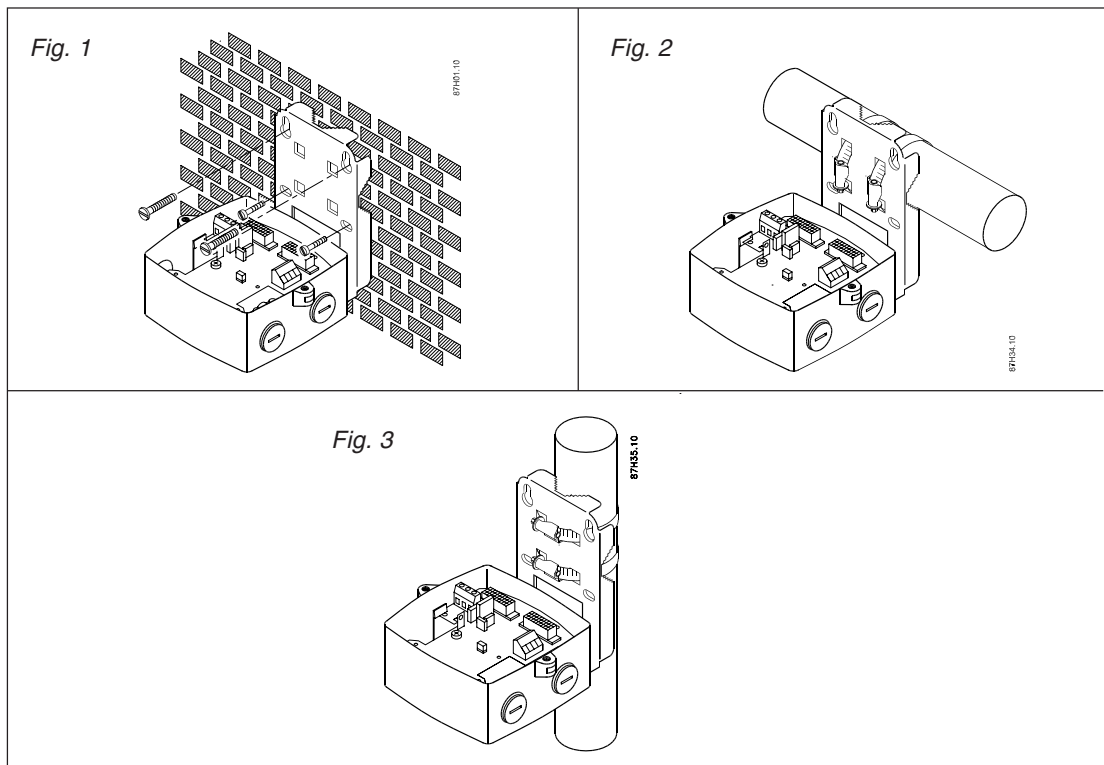

4.4.2 Connection of transducer cables

SITRANS FUS380 and FUE380 is supplied with 4 separate cables.

Cables can be used on all transducers. (The cables are not paired with a specific transducer).

Snap out the connection plate and loosen grounding wire.

Cables are ok manufactured with crimp on cable ends.

Smoothly push the cables one by one from underneath the base through the glands and adjust all four cable ends approximately 100 mm from the upper frame of the base (see figure).

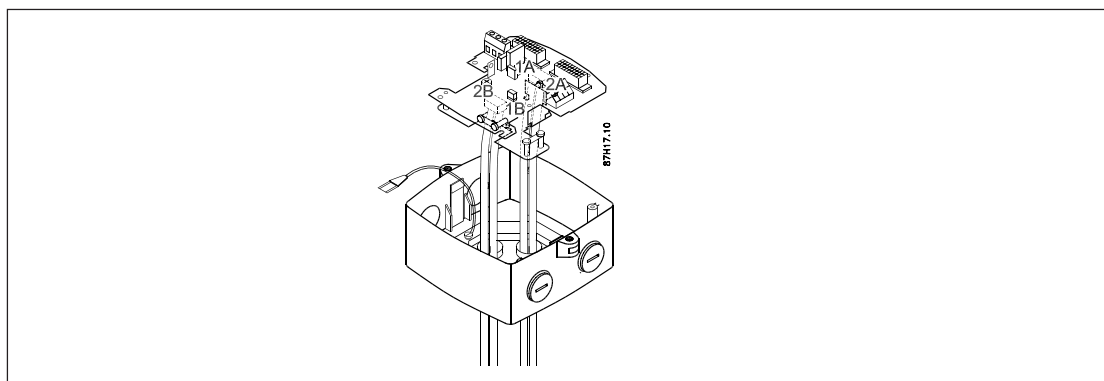

4.4.3 Transducer connection scheme

Cables 1A and 1B first track, 1A upstream, 1B downstream.
Cables 2A and 2B second track, 2A upstream, 2B downstream.

Note

Do **not** change the length of the four cables, as this will influence the accuracy of the unit.

4.4.4 Wiring diagram, base of connection board

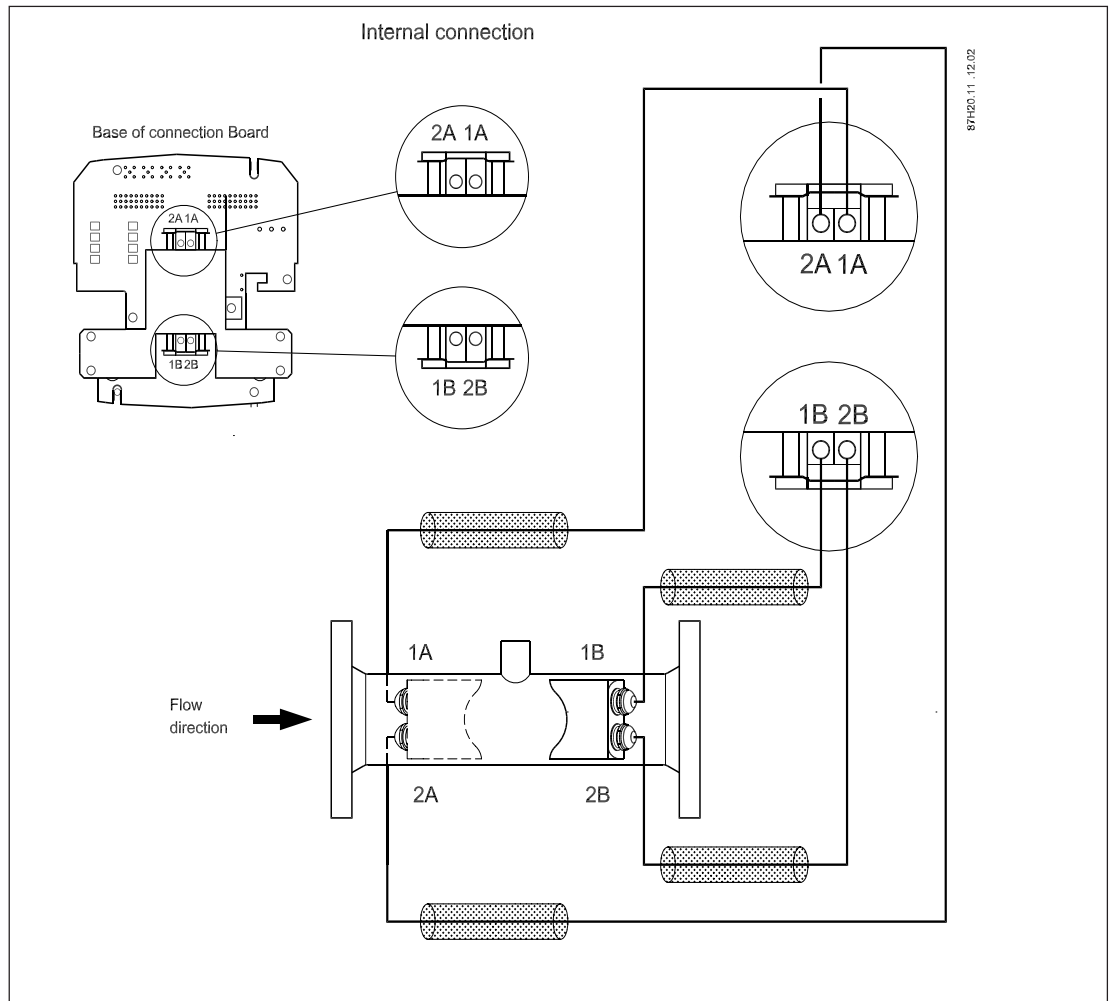

5.1 Pulse output A and B setting

Install the pulse cable through the glands, **before pushing** the printed circuit board back into place in the base part.

For compact version, install the pulse cables and power supply cable through the gland without remove the printed circuit board.

For FUS380 and FUE380 the pulse output A and B settings are depending form the ordering: Normal factory setting see following table. The settings for FUS380 can be read out and changed with a PC, the software SIMATIC PDM (Process device manager) and the IrDa optical interface (see accessories for FUS380 in FI01 catalogue). The approved FUE380 settings cannot be changed according the approval requirements, but it can be read out per PDM.

	FUS380	FUE380
Output A	Forward / reverse	Preset: Forward
Output B	Preset: Alarm	Preset: Alarm
Output B, function	Reverse pulse, alarm, call-up	Preset: Alarm
Pulse value A & B (depening on DN value)	0.1 l/p; 0.25 l/p; 0.5 l/p; 1 l/p; 2.5 l/p; 10 l/p; 25 l/p; 50 l/p; 100 l/p; 250 l/p; 500 l/p; 1 m3/p; 2.5 m3/p; 5 m3/p; 10 m3/p; 25 m3/p; 50 m3/p; 100 m3/p; 250 m3/p; 500 m3/p; 1000 m3/p	Preset: See scheme to FUE380. Settings typically for SITRANS FUE950 energy calculator.
Pulse with	5; 10; 20; 50; 100; 200; 500 ms	Preset: 5 ms

5.1.1 FUE380 preset pulse output A settings dedicated to energy calculator type SITRANS FUE950

Output A, terminals 56/57:

Pulse rate can be seen on the transmitter side label and **must correspond** to the pulse setting of the energy calculator type.

Factory pre-settings SITRANS FUE380. (Pulse width 5 ms).

DN	Pulse setting (liter/pulse)
50	1
65	1
80	2.5
100	2.5
125	2.5
150	10
200	10
250	10
300	50
350	50
400	50
500	100
600	100
700	100
800	100
900	100
1000	100
1200	100

5.1.2 FUS380 and FUE380 preset output B settings

Output B, terminals 66/67:
SITRANS FUS380 and FUE380

Preset to alarm indication - see Fig. 1:

Example: If track 1 is not measuring, a „triangle“ alert appears on the display. The failure code „F1“ appears in display menu 4, and the relay output terminals switch to „off“.

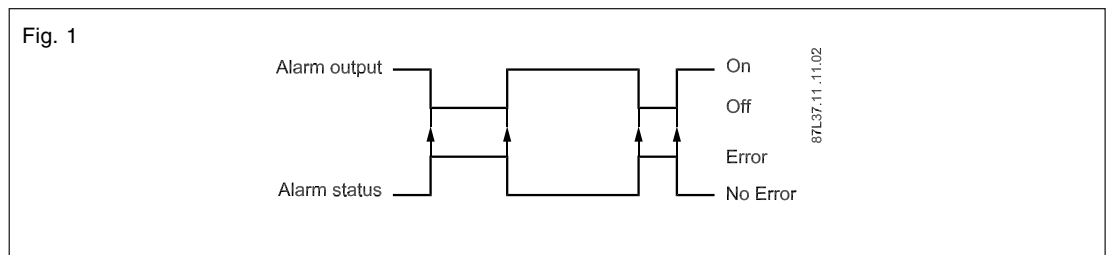

Call up indication - see Fig. 2:

The call up output is active until manually reset by use of PDM* program. The call-up function is also activated when alarm output function is activated.

* SIMATIC PDM - Process Device Manager, see accessories / spare parts in catalogue FI01.

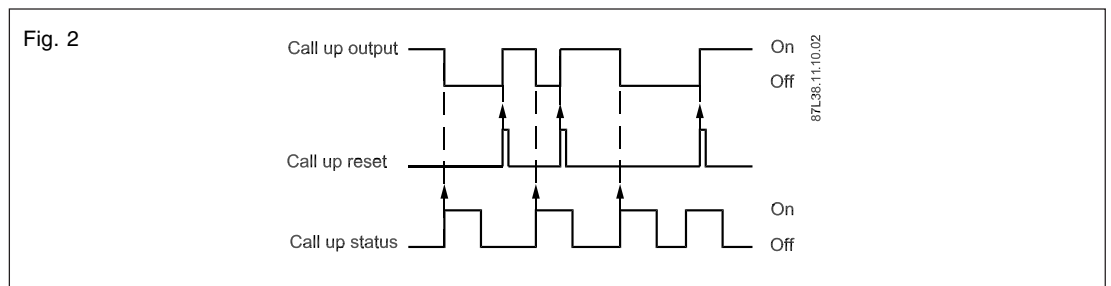

5.1.3 Wiring diagram for connection to energy calculator type SITRANS FUE950

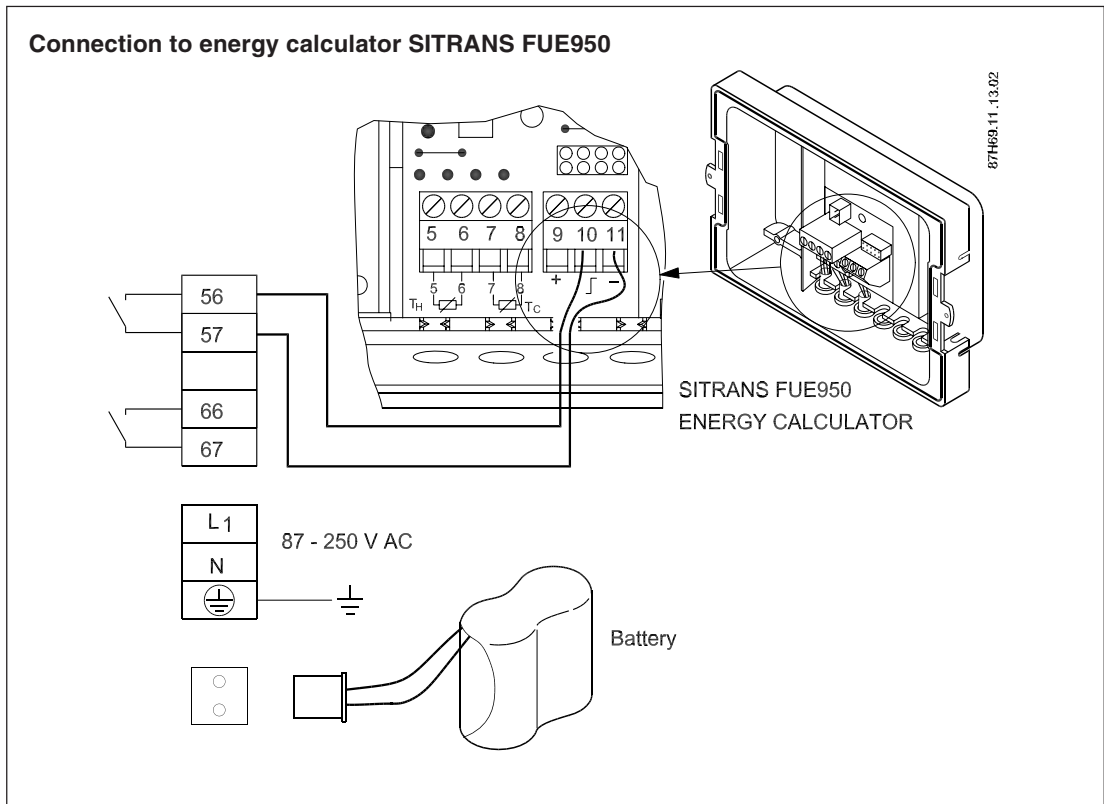

Max. cable length between energy calculator SITRANS FUE950 and SITRANS FUE380 = 20 meter.

Important

Pulse output from the flowmeter **must** correspond to pulse input setting on the energy calculator.

6.1 Flowmeter operation via key and display

After fitting new batteries, reset the internal power calculation counter to correctly indicate the power capacity.

When new batteries are installed, the flowmeter startup routine begins. First, the display shows the active software version. Then the message „reset.bat“ will appear. Press the key within six seconds to reset the internal counter. When the internal counter is reset the battery symbol will indicate „full“.

Press the key within 6 seconds. The message „accept“ will appear, the internal counter will be reset, and the battery indicator will show „full“ - see Fig. 1.

The transmitter control panel is designed with a single key and a digital display for optimal dialog - see Fig. 2 and Fig 3.

Key

Activate the key to toggle to the next index and related information - see Fig.2.

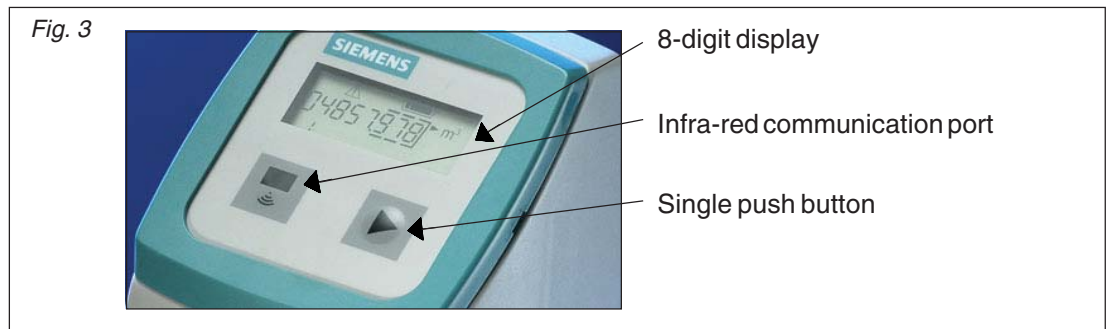
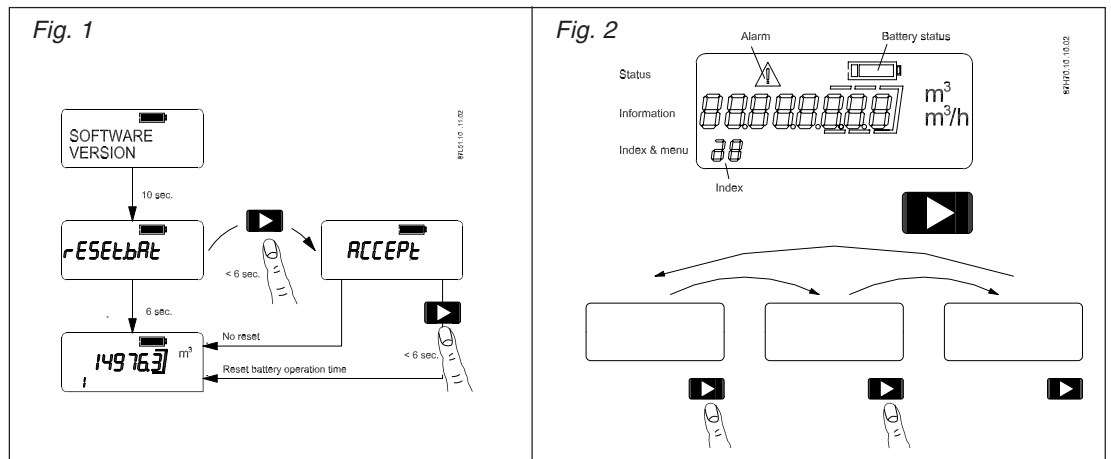

6.2 Operator menu

Menu 1

Flow volume totalizer 1.
Battery icon shows full.



Menu 2 (FUS380 only)

Flow volume totalizer 2 (factory configured for reverse flow).
Negative values indicate reverse flow calculation.



Menu 3

Actual flow rate.
Negative values indicate reverse flow.

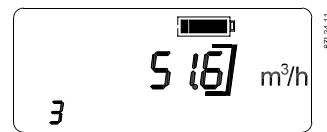

Menu 4

Failure information.
Each code indicates a specific failure.

F	No failure (normal indication)
F1	Track 1 not measuring
F2	Track 2 not measuring
F3	Internal failure
F4	Internal failure
F5	Battery low
F6	Flow overload
F7	Pulse freq. overload output A
F8	Pulse freq. overload output B

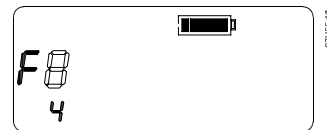

Failure code combinations:

F12 is the equivalent of F1 and F2 simultaneously:
track 1 and track 2 are not measuring.

Display test

Check of all segments.
Display toggles between all segments on/off.

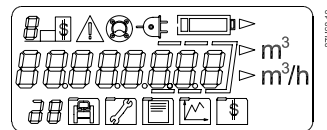

6.3 Information symbols

The status information symbols show the actual status of important flowmeter elements.

The warning symbol appears when the ultrasonic sensors do not measure or when a failure occurs according to menu 4.

The warning symbol disappears when the problem is rectified.

The mains power supply symbol appears when mains power is connected to the transmitter.

There are two symbols for battery charge status. The „battery full“ symbol indicates the battery charge is above the warning level (6-year hour counter).

The „battery low“ symbol indicates that the battery charge is below the warning level and the battery should be replaced. The battery low symbol indicates only that the battery charge is below a pre-set level, not that the charge is zero. Flow measurement continues uninterrupted when the battery low symbol appears, until battery is completely drained.

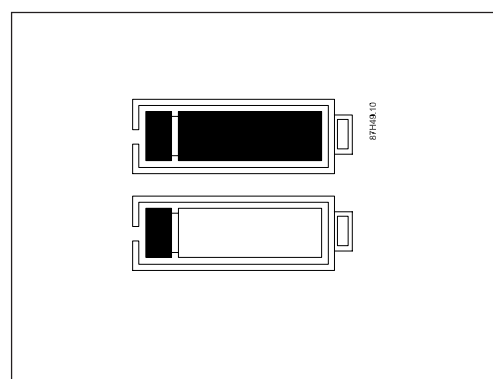
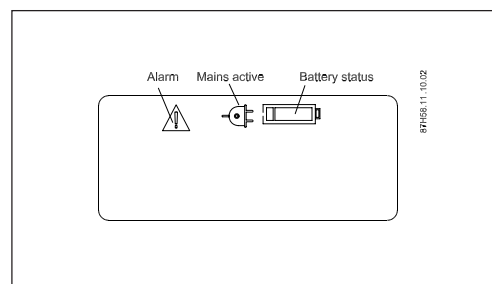

Troubleshooting

7

7.1 Alarm code

Alarm code	Failure	Remedy
Blank display	Battery plug not connected, or battery empty, mains power interrupted	Check flowmeter version. Battery version not able to run on mains power Battery version: Replace battery pack
F1	Track 1 (upper track) not measuring	No water in upper part of pipe and/or cables or transducer 1A or 1B defect
F2	Track 2 (lower track) not measuring	No water in lower part of pipe and/or cables or transducers for 2A or 2B defect
F3	Internal software failure	Contact supplier
F4	Internal software failure	Contact supplier
F5	Battery charge below preset limitation	Replace battery pack
F6	Flow exceeds preset flow rate in unit (max. speed 10 m/s)	Water flow in pipe too fast
F7	Pulse output A overflow	Pulse output exceeds 100 Hz
F8	Pulse output B overflow	Pulse output exceeds 100 Hz

Example:

Failure information in display F12. This indicates a combination of failure codes F1 and F2.

Diagnosis:

No water in pipe, or track 1 and 2 cables defect, or transducers defect.

8.1 User sealing of the SITRANS FUE380

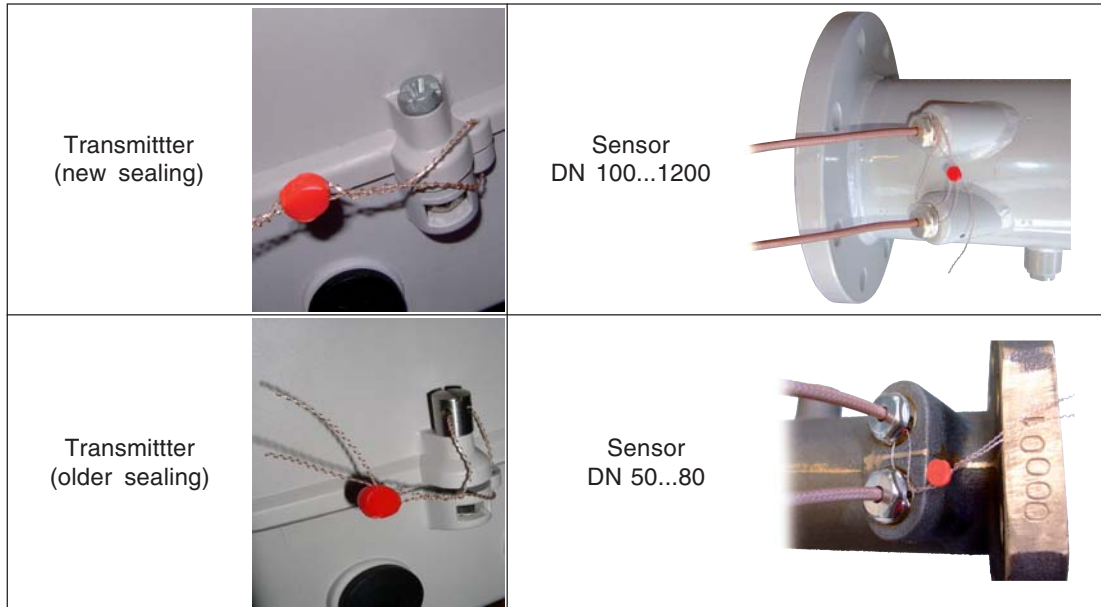

8.2 Verification sealing of the SITRANS FUE380

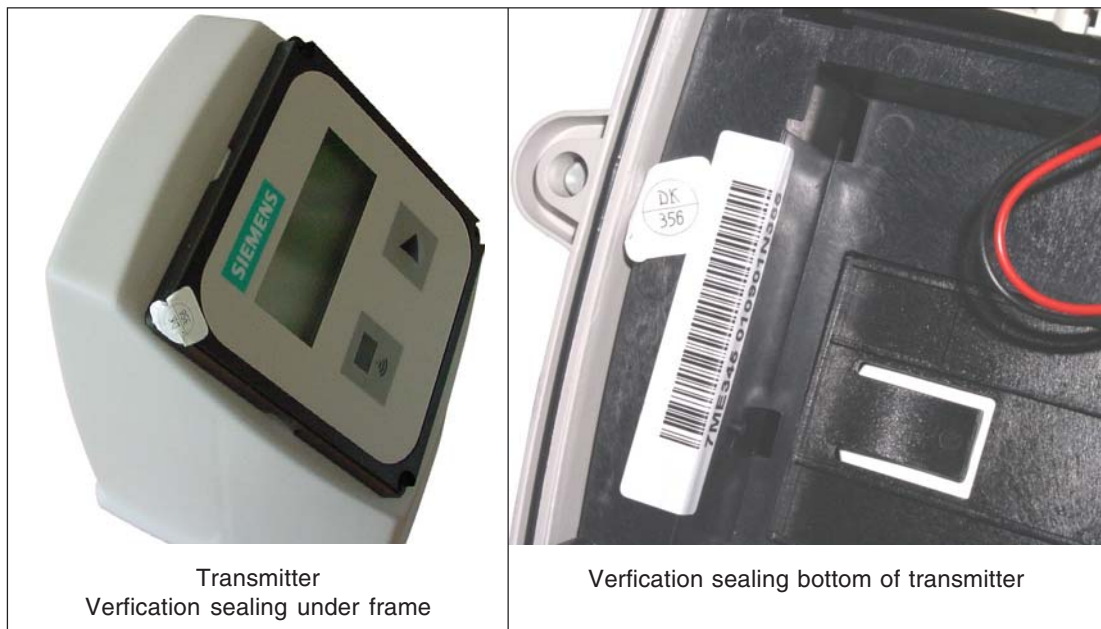

9.1 Technical data SITRANS FUS380 and FUE380

Description	Specification
Transmitter FUS080	
Enclosure	IP67 according to EN 60529 and DIN 40050 (NEMA 4X/6)
Ambient temperature	0 °C ...60 °C (32 °F.... 140 °F)
Storage temperature	-35 °C...85 °C (-40 °F...185 °F)
Installation	Cable max. 5, 10, 20, 30 m (16.4, 33, 65, 90 ft) from sensor
Mechanical vibration	2 g, 1...800 Hz sinusoidal in all directions to IEC 68-2-6
Design	Fibre glass reinforced polyamide in light-gray color
Power supply	<ul style="list-style-type: none"> • Battery: replaceable 3.6 V LiSOCl (Lithium Thionyl Chloride) battery pack 32 Ah • Mains: 87 ... 265 V AC (50 ... 60 Hz)
Battery change interval	6 years at 60 °C (140 °F) operation
Display	LCD, 8 digits, additional 2 digits and symbols for status information
Push button	One push button for toggling between display information
Measuring function	0.5 Hz battery mode or 20 Hz mains powered
Communication	IrDA on the display panel (MODBUS RTU protocol); separate add on serial interface moduls RS232 or RS485 (also MODBUS RTU protocol)
Digital output	Two passive galvanically isolated open drain-mos outputs A and B Max. ±35 V, 50 mA
Pulse output A	Preset to pulse output for forward flow
Pulse output B	Preset to alarm for present failure
Pulse width	5, 10, 20, 50, 100, 200, 500 ms
Max. pulse frequency	100 Hz
Volume units	FUE380: m ³ FUS380: Preset at ordering (default)
Flow units	FUE380: m ³ /h (default) FUS380: Preset at ordering
Alarm codes	Track 1, 2 measuring, internal failure, battery low, flow overload, pulse output frequency overload
Cable length	Max. 30 meter between transmitter and pipe (factory sets: 5, 10, 20, 30 m)
EMC	Emission EN 61000-6-4 Immunity EN 61000-6-2
Weight	Transmitter: 1.5 kg (3 lb)
Sensor to FUS380 and FUE380	
Pipe design	2-track sensor with flanges and integrated transducers wet calibrated from factory
Nominal size	DN 50, 65, 80, 100, 125, 150, 200, 250, 300, 350, 400, 500, 600, 700, 800, 900, 1000, 1200
Pressure rate	PN 16, PN 25, PN 40, EN 1092-1
Pipe material	DN 50 ... 80: Red brass DN 100 ... 1200: Carbon Steel EN 1.0345 / p235 GH, painted in light-gray
Transducer design	DN 50 ... 80: Mounted in the sensor. DN 100 ... 1200: Integrated version welded onto the pipe.
Transducer material	Stainless steel (AISI 316 / 1.4404) / brass (CuZn36Pb2as)
Media temperature	Compact: DN 50 ... 1200: 2 ... 120 °C (35.6 ... 248 °F) Remote: DN 50 ... 80: 2 ... 150 °C (35.6 ... 302 °F) DN 100 ... 1200: 2 ... 200 °C (35.6 ... 392 °F)

9.2 Dimensional drawings for FUS380 and FUE380

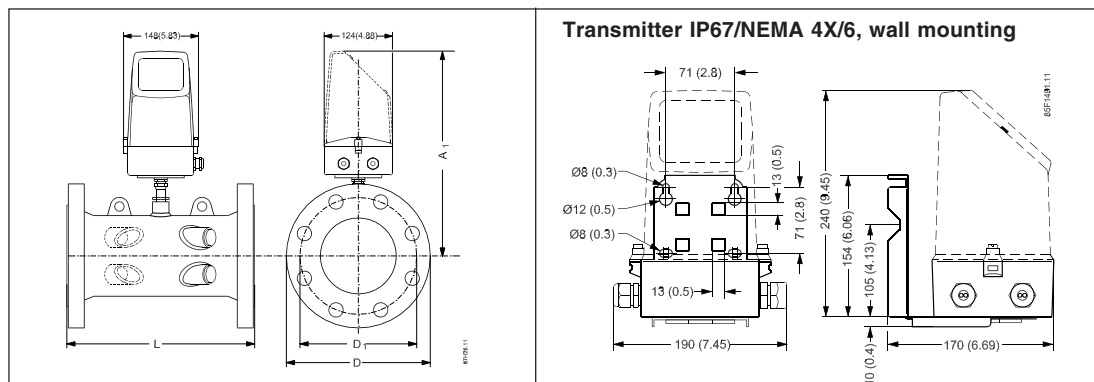

9.2.1 Pipe dimensions for FUS380 and FUE380

Size	PN 16		PN 25		PN 40		A1	D	D1	Lift hug
	L	Weight	L	Weight	L	Weight				
DN	mm	kg	mm	kg	mm	kg	mm	mm	mm	
50	-			-	300+0-2	10	350	165	125	No
65	-			-	300+0-2	15	360	185	145	No
80	-			-	350+0-2	18	370	200	160	No
100	350+0-2	15	-	-	350+0-3	18	375	220	180	No
125	350+0-2	18	-	-	350+0-3	24	380	250	210	No
150	500+0-3	28	-	-	500+0-3	34	390	285	240	Yes
200	500+0-3	38	500+0-3	47	500+0-3	55	414	340	295	Yes
250	600+0-3	60	600+0-3	76	600+0-3	91	440	405	355	Yes
300	500+0-3	66	500+0-3	81	-	-	466	460	410	Yes
350	550+0-3	94	550+0-3	121	-	-	495	520	470	Yes
400	550+0-3	124	550+0-3	153	-	-	507	580	525	Yes
500	625+0-3	190	625+0-3	244	-	-	558	715	650	Yes
600	750+0-3	303	750+0-3	365	-	-	609	840	770	Yes
700	875+0-3	361	875+0-3	552	-	-	660	910	840	Yes
800	1000+0-3	494	1000+0-3	770	-	-	710	1025	950	Yes
900	1230 +/-6	475	1300 +/-6	835	-	-	810	1125	1050	Yes
1000	1300 +/-6	594	1370 +/-6	1078	-	-	910	1255	1170	Yes
1200	1360 +/-6	732	-	-	-	-	1110	1485	1390	Yes

Notes:

- Weight for transmitter/electronics 1.5 kg (3.3 lb).
- D and D1 are values for standard versions (with standard flanges).
For versions with higher pressure ratings - see EN 1092-1.
- - Means not available.

Size	PN 16		PN 25		PN 40		A1	D	D1	Lift
	L	Weight	L	Weight	L	Weight				
inch	inch	lb	inch	lb	inch	lb	inch	inch	inch	lug
2"	-		-		12 +0-0.08	22	14	6.6	5	No
2 1/2"	-		-		12 +0-0.08	33	14.4	7.4	5.8	No
3"	-		-		14 +0-0.08	40	14.8	8	6.4	No
4	13.77+0-0.08	33	-	-	13.77+0-0.12	40	15	8.66	7.09	No
5	13.77+0-0.08	40	-	-	13.77+0-0.12	53	15.2	9.84	8.27	No
6	19.68+0-0.12	62	-	-	19.68+0-0.12	75	15.6	11.22	9.45	Yes
8	19.68+0-0.12	84	19.68+0-0.12	104	19.68+0-0.12	121	16.30	13.39	11.61	Yes
10	23.62+0-0.12	132	23.62+0-0.12	168	23.62+0-0.12	201	17.32	15.94	13.98	Yes
12	19.68+0-0.12	146	19.68+0-0.12	179	-	-	18.35	18.11	16.14	Yes
14	21.65+0-0.12	207	21.65+0-0.12	267	-	-	19.8	20.8	18.8	Yes
16	21.65+0-0.12	273	21.65+0-0.12	337	-	-	19.96	22.83	20.67	Yes
20	24.61+0-3	419	24.61+0-3	538	-	-	21.97	28.15	25.59	Yes
24	29.53+0-0.12	668	29.53+0-0.12	805	-	-	23.98	33.07	30.31	Yes
28	34.45+0-0.12	796	34.45+0-0.12	1217	-	-	25.98	35.83	33.07	Yes
32	39.37+0-0.12	1089	39.37+0-0.12	1698	-	-	27.95	40.35	37.40	Yes
36"	49.2 +/-0.24	1047	52 +/-0.24	1841	-		32.4	45	42	Yes
40"	52 +/-0.24	1309	54.8 +/-0.34	2376	-		36.4	50.2	46.8	Yes
48"	54.4 +/-0.24	1614	-		-		44.4	59.4	55.6	Yes

Notes:

- Weight for transmitter/electronics 1.5 kg (3.3 lb).
- D and D1 are values for standard versions (with standard flanges).
For versions with higher pressure ratings - see EN 1092-1.
- - Means not available.

Ordering

10

10.1 FUS380 selection and ordering data

Flowmeter SITRANS FUS380 (standard)			Order-No.	Order code
			7ME 3 4 0 0 -	
			[][][][0]-[][][A]	
Diameter	max. flow range			
	Qp [m³/h]	Qs [m³/h]		
DN 50 / 2"¹)	15	15	1 A	
DN 50 / 2"¹)	15	45	1 C	
DN 50 / 2"¹)	30	45	1 D	
DN 65 / 2½"¹)	25	25	1 E	
DN 65 / 2½"¹)	25	75	1 G	
DN 65 / 2½"¹)	50	72	1 H	
DN 80 / 3"¹)	40	40	1 J	
DN 80 / 3"¹)	40	120	1 L	
DN 80 / 3"¹)	40	120	1 M	
DN 100 / 4"	60	60	1 N	
DN 100 / 4"	60	180	1 Q	
DN 100 / 4"	120	240	1 R	
DN 125 / 5"	100	100	1 S	
DN 125 / 5"	100	280	1 U	
DN 125 / 5"	200	400	1 V	
DN 150 / 6"	150	150	2 A	
DN 150 / 6"	150	420	2 C	
DN 150 / 6"	300	560	2 D	
DN 200 / 8"	250	250	2 E	
DN 200 / 8"	250	700	2 G	
DN 200 / 8"	500	900	2 H	
DN 250 / 10"	400	400	2 J	
DN 250 / 10"	400	1120	2 L	
DN 250 / 10"	800	1400	2 M	
DN 300 / 12"	560	560	2 N	
DN 300 / 12"	560	1560	2 Q	
DN 300 / 12"	1120	2100	2 R	
DN 350 / 14"	750	750	2 S	
DN 350 / 14"	750	2100	2 U	
DN 350 / 14"	1500	2800	2 V	
DN 400 / 16"	950	950	3 A	
DN 400 / 16"	950	2660	3 C	
DN 400 / 16"	1900	3600	3 D	
DN 500 / 20"	1475	1475	3 J	
DN 500 / 20"	1475	4130	3 L	
DN 500 / 20"	2950	5500	3 M	
DN 600 / 24"	2150	2150	3 S	
DN 600 / 24"	2150	6020	3 U	
DN 600 / 24"	4300	8000	3 V	
DN 700 / 28"	2900	2900	4 E	
DN 700 / 28"	2900	8120	4 G	
DN 700 / 28"	5800	10800	4 H	
DN 800 / 32"	3800	3800	4 N	
DN 800 / 32"	3800	10640	4 Q	
DN 800 / 32"	7600	14200	4 R	
DN 900 / 36"	5000	5000	5 A	
DN 900 / 36"	5000	14000	5 C	
DN 900 / 36"	10000	20000	5 D	
DN 1000 / 40"	6000	6000	5 J	
DN 1000 / 40"	6000	16800	5 L	
DN 1000 / 40"	12000	24000	5 M	
DN 1200 / 48"	9000	9000	5 S	
DN 1200 / 48"	9000	25200	5 U	
DN 1200 / 48"	18000	36000	5 V	

Flowmeter SITRANS FUS380 (standard)			Order-No.	Order code
			7ME 3 4 0 0 -	
			[][][][0]-[][][A]	
Flange norm and pressure rating				
System without sensor - only a transmitter FUS080 as spare part - settings as defined with this order no.			A	
EN 1092-1 Flanges				
PN 16 (DN 100 ... 1200)			C	
PN 25 (DN 200 ... 1000)			D	
PN 40 (DN 50 ... 250)²)			E	
Compact / remote connection				
Compact version, max. 120 °C (248 °F) up to DN 800			0	
Remote version, max. 150/200 °C (302/392 °F)				
5 m (16.4 ft)			2	
10 m (32.8 ft)			3	
20 m (65.6 ft)			4	
30 m (98.4 ft)			5	
Pulse output value setup				
0.1 l/pulse (option for DN 50...DN 65)			1	
1 l/pulse (typical for DN 50...DN 65)			2	
2.5 l/pulse (typical for DN 80...DN 125)			3	
10 l/pulse (typical for DN 150...DN 250)			4	
50 l/pulse (typical for DN 300...DN 400)			5	
100 l/pulse (typical for DN 500...DN 1200)			6	
250 l/pulse			7	
1 m³/pulse			8	
0.25 l/pulse			9	NOA
0.5 l/pulse			9	NOB
5 l/pulse			9	NOC
25 l/pulse			9	NOD
500 l/pulse			9	NOE
2.5 m³/pulse			9	NOF
5 m³/pulse			9	NOG
10 m³/pulse			9	NOH
25 m³/pulse			9	NOJ
50 m³/pulse			9	NOK
100 m³/pulse			9	NOL
250 m³/pulse			9	NOM
500 m³/pulse			9	NON
1000 m³/pulse			9	NOP
Transmitter SITRANS FUS080				
IP67/NEMA 4X/6 115...230 V AC			B	
IP67/NEMA 4X/6 (3.6 V battery supply)			D	
IP67/NEMA 4X/6 115...230 V AC, including 3.6 V battery back up			E	
IP67/NEMA 4X/6 3.6 V battery version (no battery included)³)			G	
Pulse width setup				
5 ms (standard)			2	
10 ms			3	
20 ms			4	
50 ms			5	
100 ms			6	
200 ms			7	
500 ms			8	

Additional information	Order code
Please add „-Z“ to order No. and following add-on code(s) with plain text	
Accredited Siemens calibration FUS380	
Accredited Siemens ISO/IEC 17025 calibration. Max. flow 50 ... 250 m ³ /h, depending on dimension (DN 50...200)	D20
Accredited Siemens ISO/IEC 17025 calibration. Max. flow 250 ... 1300 m ³ /h, depending on dimension (DN 100...500)	D21
Accredited Siemens ISO/IEC 17025 calibration. Max. flow 1400 ... 4200 m ³ /h, depending on dimension (DN 300...1200)	D22
Material certificate EN 10204-3.1	F10
Tag name plate Stainless steel tag with 12 mm characters, max. 15 characters (add plain text)	Y17
Self-adhesive plastic tag with 8 mm characters, max. 15 characters (add plain text)	Y18

For accessories and spare parts see end of following chapter to FUE380.

MLFB Ordering example

Customer requires a flowmeter:

DN 250, PN 25, compact version (media temperature max. 120 °C), mains power version.

Material certificate and metal tag name plate

Pulse output for 10 l/pulse and min. 5 ms puls width.

Ordering:

FUS380: 7ME3400-2LD00-4BA2-Z, F10,Y17

- 1) Pipe material red brass
- 2) PN 40 standard for DN 50...80 red brass pipes
- 3) Lithium batteries are subject to special transportation regulations according to United nations "Regulation of Dangerous Goods, UN 3090 and UN 3091". Special transport documentation is required to observe these regulations. This may influence both transport time and costs.

10.2 FUE380 (type approved) selection and ordering data

Flowmeter SITRANS FUE380 (type approved)			Order-No.	Order code	Flowmeter SITRANS FUE380 (type approved)			Order-No.	Order code
			7ME 3 4 1 0 -					7ME 3 4 1 0 -	
Diameter	max. flow range				Flange norm and pressure rating				
	Qp [m ³ /h]	Qs [m ³ /h]			EN 1092-1				
DN 50 / 2" ¹	15 ²	30	1 B		PN 16 (DN 100 ... 1200)	C			
DN 50 / 2" ¹	15 ²	45	1 C		PN 25 (DN 200 ... 1000)	D			
DN 50 / 2" ¹	30 ³	45	1 D		PN 40 (DN 50 ... 250) ⁴	E			
					Compact / remote connection				
DN 65 / 2½" ¹	25 ²	50	1 F		Compact version, max. 120 °C (248 °F)	0			
DN 65 / 2½" ¹	25 ²	72	1 G		Remote version, max. 200 °C (392 °F)				
DN 65 / 2½" ¹	50 ³	72	1 H		5 m (16.4 ft)	2			
DN 80 / 3" ¹	40 ²	80	1 K		10 m (32.8 ft)	3			
DN 80 / 3" ¹	40 ²	120	1 L		20 m (65.6 ft)	4			
DN 80 / 3" ¹	80 ³	120	1 M		30 m (98.4 ft)	5			
					Approvals / pulse output				
DN 100 / 4"	60 ²	120	1 P		Without approval (neutral)	0			
DN 100 / 4"	60 ²	180	1 Q		Selectable pulse output				
DN 100 / 4"	120 ³	180	1 R		(following code can be 1...9)				
DN 125 / 5"	100 ²	200	1 T		With approval marks	1			
DN 125 / 5"	100 ²	280	1 U		Selectable pulse output				
DN 125 / 5"	200 ³	280	1 V		(following code can be 1...9)				
DN 150 / 6"	150 ²	300	2 B		With approval marks and seal	2			
DN 150 / 6"	150 ²	420	2 C		Selectable pulse output				
DN 150 / 6"	300 ³	420	2 D		(following code can be 1...9)				
DN 200 / 8"	250 ²	500	2 F		Without approval (neutral)	3			
DN 200 / 8"	250 ²	700	2 G		Preset pulse output for FUE950 energy meter (following code must be 2...6)				
DN 200 / 8"	500 ³	700	2 H		With approval marks	4			
DN 250 / 10"	400 ²	800	2 K		Preset pulse output for FUE950 energy meter (following code must be 2...6)				
DN 250 / 10"	400 ²	1120	2 L		With approval marks and seal	5			
DN 250 / 10"	800 ³	1120	2 M		Preset pulse output for FUE950 energy meter (following code must be 2...6)				
DN 300 / 12"	560 ²	1120	2 P		Pulse output value setup				
DN 300 / 12"	560 ²	1560	2 Q		0.1 l/pulse (option for DN 50...DN 65)	1			
DN 300 / 12"	1120 ³	1560	2 R		1 l/pulse (typical for DN 50...DN 65)	2			
DN 350 / 14"	750 ²	1500	2 T		2.5 l/pulse (typical for DN 80...DN 125)	3			
DN 350 / 14"	750 ²	2100	2 U		10 l/pulse (typical for DN 150...DN 250)	4			
DN 350 / 14"	1500 ³	2100	2 V		50 l/pulse (typical for DN 300...DN 400)	5			
DN 400 / 16"	950 ²	1900	3 B		100 l/pulse (typical for DN 500...DN 1200)	6			
DN 400 / 16"	950 ²	2660	3 C		Optional pulse values				
DN 400 / 16"	1900 ³	2660	3 D		250 l/pulse	7			
DN 500 / 20"	1475 ²	2950	3 K		1 m ³ /pulse	8			
DN 500 / 20"	1475 ²	4130	3 L		0.25 l/pulse	9			NOA
DN 500 / 20"	2950 ³	4130	3 M		0.5 l/pulse	9			NOB
DN 600 / 24"	2150 ²	4300	3 T		5 l/pulse	9			NOC
DN 600 / 24"	2150 ²	6020	3 U		25 l/pulse	9			NOD
DN 600 / 24"	4300 ³	6020	3 V		500 l/pulse	9			NOE
DN 700 / 28"	2900 ²	5800	4 F		2.5 m ³ /pulse	9			NOF
DN 700 / 28"	2900 ²	8120	4 G		5 m ³ /pulse	9			NOG
DN 700 / 28"	5800 ³	8120	4 H		10 m ³ /pulse	9			NOH
DN 800 / 32"	3800 ²	7600	4 P		25 m ³ /pulse	9			NOJ
DN 800 / 32"	3800 ²	10640	4 Q		50 m ³ /pulse	9			NOK
DN 800 / 32"	7600 ³	10640	4 R		100 m ³ /pulse	9			NOL
DN 900 / 36"	5000 ²	10000	5 B		250 m ³ /pulse	9			NOM
DN 900 / 36"	5000 ²	14000	5 C		500 m ³ /pulse	9			NON
DN 900 / 36"	10000 ³	14000	5 D		1000 m ³ /pulse	9			NOP
DN 1000 / 40"	6000 ²	12000	5 K		Transmitter SITRANS FUE080				
DN 1000 / 40"	6000 ²	16800	5 L		IP67/NEMA 4X/6 115...230 V AC				B
DN 1000 / 40"	12000 ³	16800	5 M		IP67/NEMA 4X/6 (3.6 V battery supply)				D
DN 1200 / 48"	9000 ²	18000	5 T		IP67/NEMA 4X/6 115...230 V AC,				E
DN 1200 / 48"	9000 ²	25200	5 U		including 3.6 V battery back up				
DN 1200 / 48"	18000 ³	25200	5 V		IP67/NEMA 4X/6 3.6 V battery version (no battery included) ⁵				G

	Order-No.	Order code
Flowmeter SITRANS FUE380 (type approved)	7ME 3 4 1 0 -	
Country / approved type ⁶⁾ Neutral, no approval mark		
Denmark, EN 1434/OIML R75	A	
Finland, EN 1434/OIML R75	F	
Germany, EN 1434 (PTB approved)	G	
Russia, EN 1434/OIML R75	M	
Ukraine, EN 1434/OIML R75	P	
China	Z	Q0C
MID-Approval (EN 1434/OIML R75), English	R	
MID-Approval (EN 1434/OIML R75), German	S	
MID-Approval (EN 1434/OIML R75), Polish	T	
MID-Approval (EN 1434/OIML R75), French	U	
Pulse width setup		
5 ms (standard)		2
10 ms		3
20 ms		4
50 ms		5
100 ms		6
200 ms		7
500 ms		8

- 1) Pipe material red brass
- 2) EN 1434 flow values
- 3) OIML R75 flow values
- 4) PN 40 standard for DN 50...80 red brass pipes
- 5) Lithium batteries are subject to special transportation regulations according to United nations "Regulation of Dangerous Goods, UN 3090 and UN 3091". Special transport documentation is required to observe these regulations. This may influence both transport time and costs.
- 4) Other countries in progress

Additional information	Order code
Please add „-Z“ to order No. and following add-on code(s) with plain text	
Verification FUE380 Verification certificate 2 x 3 points. Max. flow 50 ... 250 m ³ /h, depending on dimension	D10
Verification certificate 2 x 3 points. Max. flow 250 ... 1300 m ³ /h, depending on dimension	D11
Verification certificate 2 x 3 points. Max. flow 1400 ... 4200 m ³ /h, depending on dimension	D12
Accredited Siemens calibration FUE380 Accredited Siemens ISO/IEC 17025 calibration. Max. flow 50 ... 250 m ³ /h, depending on dimension (DN 50...200)	D20
Accredited Siemens ISO/IEC 17025 calibration. Max. flow 250 ... 1300 m ³ /h, depending on dimension (DN 100...500)	D21
Accredited Siemens ISO/IEC 17025 calibration. Max. flow 1400 ... 4200 m ³ /h, depending on dimension (DN 300...1200)	D22
Material certificate EN 10204-3.1	F10
Tag name plate Stainless steel tag with 12 mm characters, max. 15 characters (add plain text)	Y17
Self-adhesive plastic tag with 8 mm characters, max. 15 characters (add plain text)	Y18

MLFB Ordering example

Customer requires a flowmeter for custody transfer:
DN 250, PN 25, compact version (media temperature max. 120 °C),
battery version.
Type approved according to EN 1434, verified and sealed for
Germany.
Material certificate and metal tag name plate
Pulse output for energymeter SITRANS FUE950

Ordering:

FUE380: 7ME3410-2LD05-4DG2-Z, F10,Y17

Example of appropriate energy meter:













Energy meter type:
FUE950-03110-0R1CB-10300-DK2-00012



Please use online PIA Selector to get latest updates.

Product selector link: www.pia-selector.automation.siemens.com

10.3 Spare parts for FUS380 and FUE380

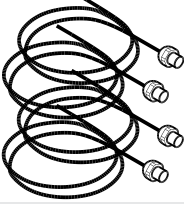
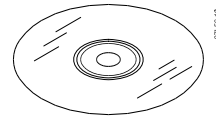
Type/Description	Order No.	Symbol
Dual battery pack (6 year lifetime) 33 Ah	FDK:087H2255	
Single battery back-up to main supply 13.5 Ah	FDK:087L4201	
Battery cover for transmitter FUS080	A5E00694468	
Pg 13.5 set (2 pcs.) for main cable/pulse cable	FDK:083G0228	
Pg 13.5 set for dual coax cable (6 mm)	A5E00694500	
Wall mounting kit for remote mounting including printed circuit board (DN 50 ... 1200 (2" ... 48") only)	A5E00694509	
Terminal box for compact mounting for DN50...DN80 compact versions including printed circuit board	A5E01208138	
Terminal box for DN100...DN1200 compact versions including printed circuit board	A5E00694660	
Brace (holder) for optical Irda eye	A5E00695277	
Irda infrared interface adapter with USB for data acquisition with 1.2 m (3.9 ft) cable	FDK:087L4163	
RS 232 add-on module, point to point communication interface with MODBUS RTU protocol	FDK:087L4212	
RS 485 add-on module, multidrop communication interface with MODBUS RTU protocol	FDK:087L4213	
5 m (16.4 ft) cable set (4 pcs.) for DN 50...80 remote mounting	A5E01208092	
10 m (32.8 ft) cable set (4 pcs.) for DN 50...80 remote mounting	A5E01208114	
20 m (65.6 ft) cable set (4 pcs.) for DN 50...80 remote mounting	A5E01208117	
30 m (98.4 ft) cable set (4 pcs.) for DN 50...80 remote mounting	A5E01208121	
1 m (3.28 ft) cable set (4 pcs.) for DN 50...80 compact version	A5E01208126	
5 m (16.4 ft) cable set (4 pcs.) for DN 100...1200 remote mounting	A5E00695476	
10 m (32.8 ft) cable set (4 pcs.) for DN 100...1200 remote mounting	A5E00695479	
20 m (65.6 ft) cable set (4 pcs.) for DN 100...1200 remote mounting	A5E00695480	
30 m (98.4 ft) cable set (4 pcs.) for DN 100...1200 remote mounting	A5E00695483	
1 m (3.28 ft) cable set (4 pcs.) for DN 100...1200 compact version	A5E00695486	
Process Device Manager SIMATIC PDM: SIMATIC PDM Single Point V6.0 For operation and parameterization of one field device, communication using PROFIBUS DP/PA or HART modem, incl. 1 TAG Cannot be expanded by further functions or TAG option/power-pack; 5 languages (German, English, French, Spanish, Italian) executes with Windows 2000 Professional or Windows XP Professional	6ES7 658- 3HX06-0YA5	

Downloads for DEVICE description FUE380: <http://support.automation.siemens.com/WW/view/en/17320235>

11.1 EC Declaration of Conformity



EC Declaration of Conformity
EG-Konformitätserklärung



No. A5E00733799A - DS03

Manufacturer:
Hersteller: Siemens Flow Instruments A/S

Address:
Anschrift: Nordborgvej 81, 6430 Nordborg, DK-Denmark

Product description:
Produktbezeichnung Flow transmitter / Durchfluss meßumformer
SITRANS FUS080, FUE080, FUE380, FUS380
Type / Typ 7ME340 (standard) and 7ME341 (type approved)

The product described above in the form as delivered is in conformity with the provisions of the following European Directives:

Das bezeichnete Produkt stimmt in der von uns in Verkehr gebrachten Ausführung mit den Vorschriften folgender Europäischer Richtlinien überein:

- | | |
|--------------------|--|
| 2004/108/EC
EMC | Directive of the European Parliament and of the Council on the approximation of the laws of the Member States relating to electromagnetic compatibility and repealing Directive 89/336/EEC.
<i>Richtlinie des Europäischen Parlaments und des Rates zur Angleichung der Rechtsvorschriften der Mitgliedstaaten über die elektromagnetische Verträglichkeit und zur Aufhebung der Richtlinie 89/336/EWG.</i> |
| 2006/95/EC
LVD | Directive of the European Parliament and of the Council on the harmonisation of the laws of Member States relating to electrical equipment designed for use within certain voltage limits.
<i>Richtlinie des Europäischen Parlaments und des Rates zur Angleichung der Rechtsvorschriften der Mitgliedstaaten betreffend elektrische Betriebsmittel zur Verwendung innerhalb bestimmter Spannungsgrenzen.</i> |
| 97/23/EC
PED | Directive of the European Parliament and of the Council on the approximation of the laws of the Member States concerning pressure equipment.
<i>Richtlinie des Europäischen Parlaments und des Rates zur Angleichung der Rechtsvorschriften der Mitgliedstaaten über Druckgeräte</i> |
| 2004/22/EC
MID | Directive of the European Parliament and the Council on the approximation of the laws of the Member States concerning equipment intended for Legal Metrological Measuring systems.
<i>Richtlinie des Europäischen Parlaments und des Rates zur Angleichung der Rechtsvorschriften der Mitgliedstaaten für Geräte zur bestimmungsgemäßen Verwendung in Legale Metrologische Messsysteme.</i> |

Siemens Aktiengesellschaft: Chairman of the Supervisory Board: Gerhard Cromme;
Managing Board: Peter Löscher, Chairman, President and Chief Executive Officer; Johannes Feldmayer, Heinrich Hiesinger, Joe Kaeser, Rudi Lamprecht, Eduardo Montes, Juergen Radomski, Erich R. Reinhardt, Hermann Requardt, Uriel J. Sharef, Klaus Wucherer;
Registered offices: Berlin and Munich, Commercial registries: Berlin Charlottenburg, HRB 12300, Munich, HRB 6684
WEEE-Reg.-Nr. DE 23691322

Page 1 / 3

Annex A is integral part of this declaration.

Anhang A ist integraler Bestandteil dieser Erklärung.

This declaration certifies the conformity to the specified directives but contains no assurance of properties. The safety documentation accompanying the product shall be considered in detail.

Diese Erklärung bescheinigt die Übereinstimmung mit den genannten Richtlinien, ist jedoch keine Beschaffenheits- oder Haltbarkeitsgarantie nach §443 BGB.

Die Sicherheitshinweise der mitgelieferten Produktdokumentation sind zu beachten.

Nordborg, 28.08.2007

Siemens Flow Instruments A/S

2818-07

28-8-2007

J. Parkum, R&D Manager



O.Kirk-Andersen, Quality Manager

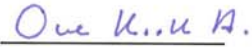

Name, function
Name, Funktion

signatur
Unterschrift

Name, function
Name, Funktion

signatur
Unterschrift

Annex A to the EC Declaration of Conformity Anhang A zur EG-Konformitätserklärung

No. A5E00733799A - DS03

Product description:
Produktbezeichnung

Flow transmitter / Durchfluss meßumformer
SITRANS FUS080, FUE080, FUE380, FUS380
Type / Typ 7ME340 (standard) and 7ME341 (type approved)

Conformity to the Directives indicated on page 1 is assured through the application of the following standards (depending on versions):
Die Konformität mit den auf Blatt 1 angeführten Richtlinien wird nachgewiesen durch die Einhaltung folgender Normen (variantenabhängig):

Directives
Richtlinien

Directive Richtlinie	Standard / Reference number Norm / Referenznummer	Edition Ausgabe datum	7ME340 7ME341 g-hjklm-npqr	7ME340 7ME341 g-hjklm-npqr	7ME345 g-hjklm-npqr	7ME345 g-hjklm-npqr
2004/108/EC	EN 61326-1 *	2006	p = B;E	p = D;G	l = 3;4	l = 1;2
2004/108/EC	EN 61326-2-5	2006	p = B;E	p = D;G	l = 3;4	l = 1;2
2006/95/EC	EN 61010-1	2001	p = B;E		l = 3;4	
97/23/EEC	Annex III, Module H	1999	p = B;E	p = D;G		
2004/22/EC	EN1434	2006	q =R;S;T;U	q =R;S;T;U		

* all environments included

Certificates
Zertifikate

Certificates Zertifikate	7ME341 g-hjklm-npqr	7ME341 g-hjklm-npqr		
FORCE-Dantest: DK-0200-MI004-005	q =R;S;T;U	q =R;S;T;U		

Inspection / Surveillance:
Kontrolle / Überwachung:

Directive Richtlinie	Notified Body Product Quality Assurance Benannte Stelle Qualitätssicherung Produktion		No.:
2004/22/EC	MID	FORCE-Dantest CERT	0200
97/23/EC	PED	FORCE-Dantest CERT	0200

Siemens has checked the contents of this manual for agreement with the hardware and software described. Since deviations cannot be precluded entirely, Siemens cannot guarantee full agreement. However, the data in this manual are reviewed regularly and any necessary corrections included in subsequent editions. Suggestions for improvement are always welcome.

Technical data subject to change without prior notice.

The reproduction, transmission or use of this document or its contents is not permitted without express written authority. Offenders will be liable for damages. All rights, including rights created by patent grant or registration of a utility model or design, are reserved.

Copyright © Siemens AG 09.2007 All Rights Reserved